



**OFICINA 90:****REGALE ALUMINIUM VOUS PRESENTE SA NOUVELLE GAMME DE CLOISONS AMOVIBLES****DESCRIPTIF TECHNIQUE :**

- Cloison amovible à couvre-joint sur structure de profilé aluminium.
- Pôteau principal d'une largeur de 83 mm.
- Profilé spécial pour plinthe électrique permettant l'encastrement des câbles.

REMPLISSAGE :

- Cloison vitrée de 6 à 10 mm. simple ou bien double sur toute la hauteur, option verre sérigraphié, sablé ou teinté.
- Cloison pleine en bois de 10 à 12 mm.
- Cloison vitrée sur allège pleine







TYPE D'OUVERTURE POSSIBLE :

- Porte vitrée en profilé aluminium.
- Porte en vitrage trempé.
- Porte pleine en bois.
- Porte mixte verre et bois.

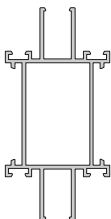
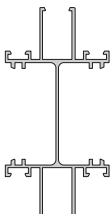

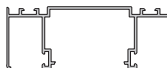

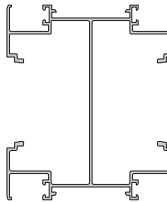
LES AVANTAGES DE LA CLOISON AMOVIBLE :

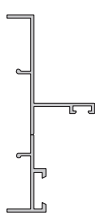
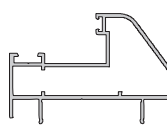
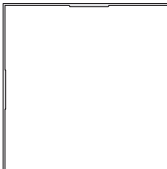
- Réalisation robuste, design et modulable.
- Assemblage avec couvre joint apparent, ou en bord à bord sans montant.
- Finition <NATURELLE>, ou laquée avec coloris <RAL>, givrés ou métallisés.
- Solutions monobloc possible pour la division régulière des espaces.
- Pose ultra rapide pour libérer ou réagencer vos locaux en un minimum de temps.
- Aucune dégradation des sols, des murs ni des plafonds.
- Réduction acoustique.
- Une adaptabilité à toute épreuve.

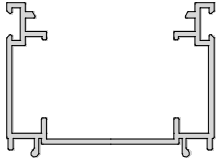

Profilsés	Réf.	Désignation	Inertie IX cm4	Inertie IYcm4
	100	Poteau tubulaire	1.57	0.18
	101	Poteau	18.73	3.38
	102	Cache extérieur	0.03	0.09
	103	Longrine haute et basse	28.5	3.54
	104	Capot double vitrage	0.02	1.58
	106	Plinthe électrique	89.80	52.58
	107	Cache extérieur plinthe électrique	2.51	0.086
	108	Huisserie porte	12.84	1.20
	108A	Huisserie porte Tubulaire	30.47	9.08
	119	Poteau tube 88x88	47.30	47.62

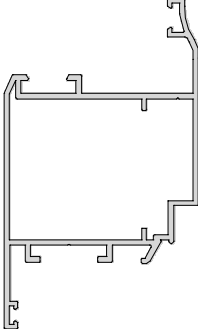
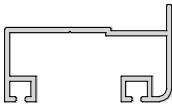
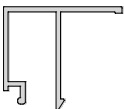
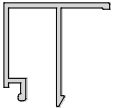
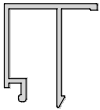

Profilsés	Réf.	Désignation	Inertie IX cm ⁴	Inertie IYcm ⁴
	112	Equarteur	8.21	3.12
	113	longrine haute et basse	23.51	2.65
	527	Ouvrant en Z grand tubulaire	23.62	10.47
	516	Bas de porte	3	0.6
	530	Parcloses de 28	0.74	0.37
	531	Parcloses de 25	0.63	0.33
	532	Parcloses de 22	0.56	0.30
	533	Parcloses de 13	0.46	0.16



100

Poteau Tubulaire

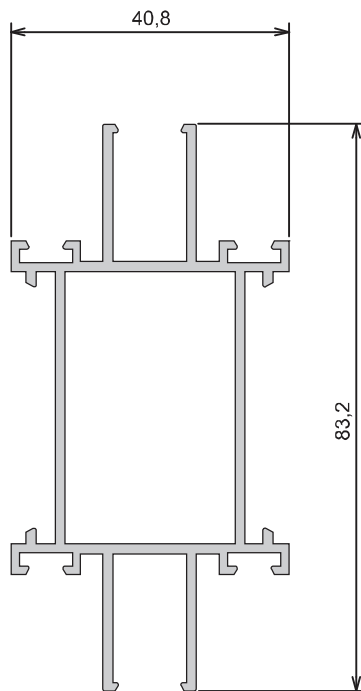

101

Poteau

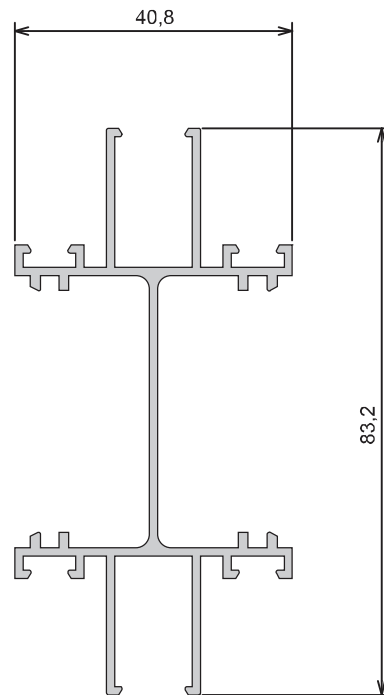

102

Cache extérieur

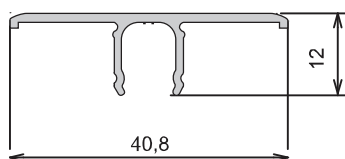

104

Capot double
vitrage

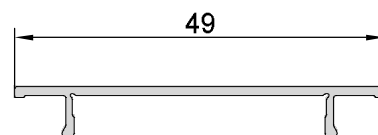



113

Longrine Haute et basse

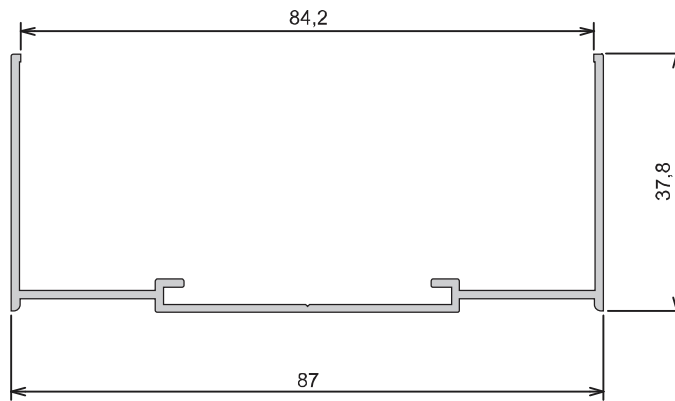

103

Longrine Haute et basse

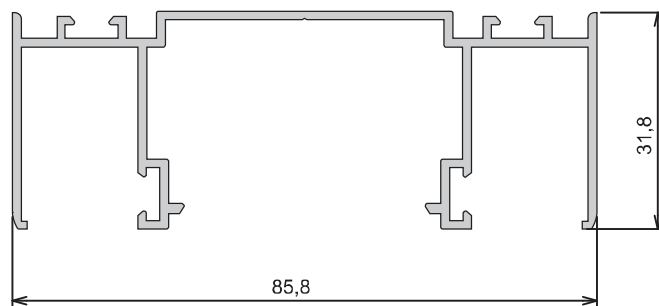



106

Plinthe électrique

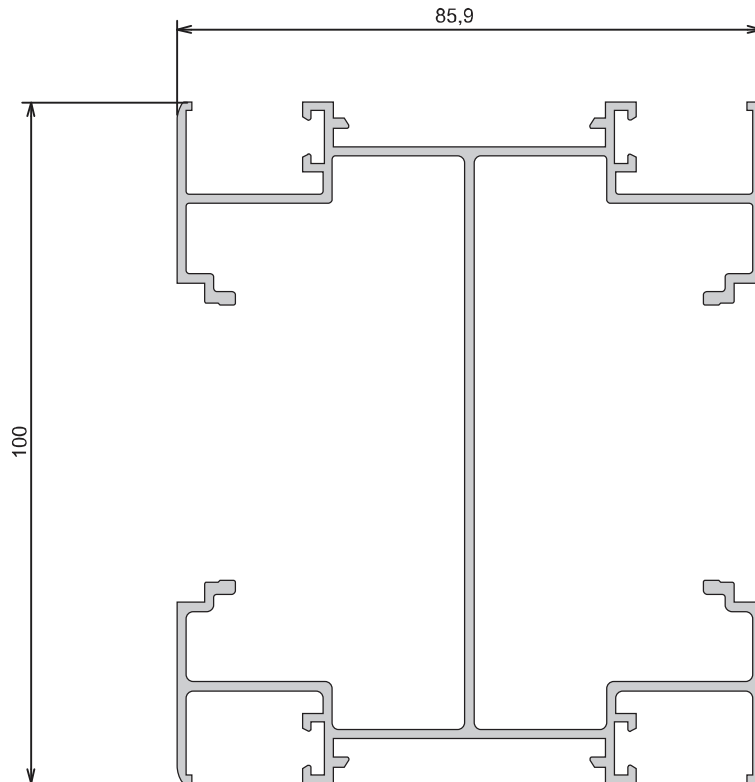

107

Cache extérieur plinthe électrique

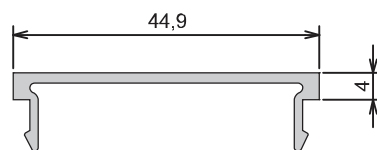

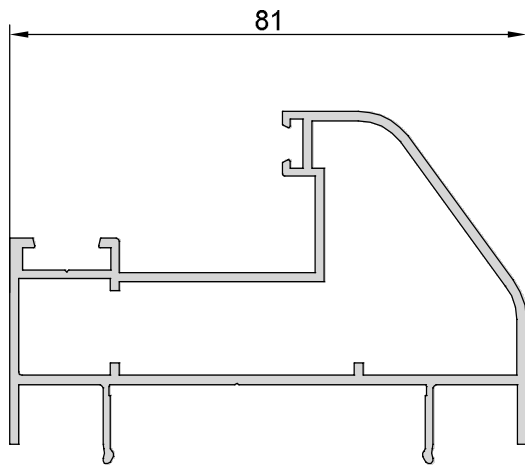

108A

Huisserie de porte tubulaire

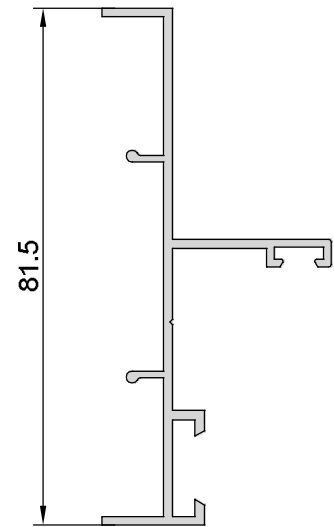

108

Huisserie de porte

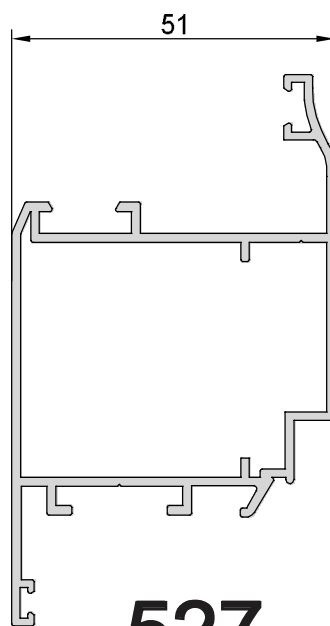

527

Ouvrant en Z



530

Parclose de 28

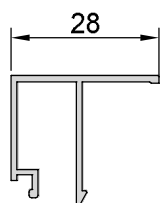

531

Parclose de 25

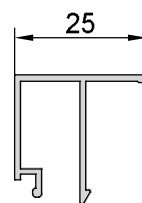

516

Bas de porte

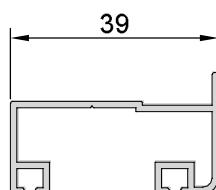

532

Parclose de 22

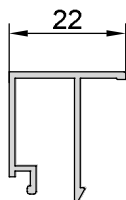

533

Parclose de 13

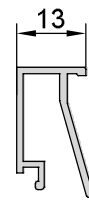



112

Closoir intérieur longrine

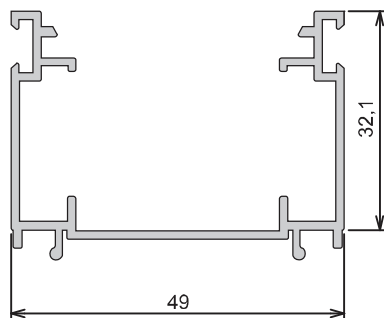





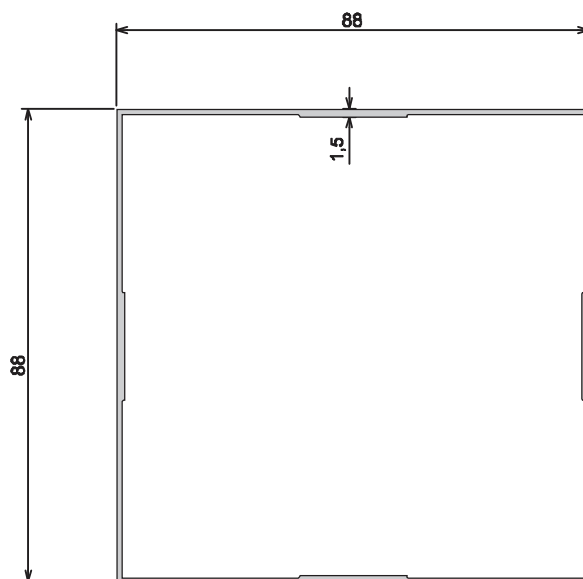



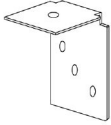

119

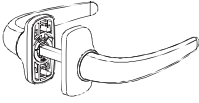
Poteau de départ 88x88

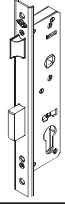



OFICINA 90

Réf.	Article	Description	Réf.	Article	Description
120		Equerre de fixation pouteau	599		Joint de 2mm
554F		Poignée Béquille	595		Joint de 4mm
583		Serreure 1 point Complète	597		Joint de 6mm
592		Joint de battement	194		Joint 6 mm
593		Joint extérieur	193		Joint 8 mm
596		Joint dormant			