

VEC

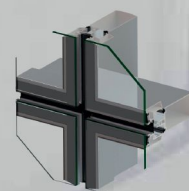

**PROFILES:**

VEC

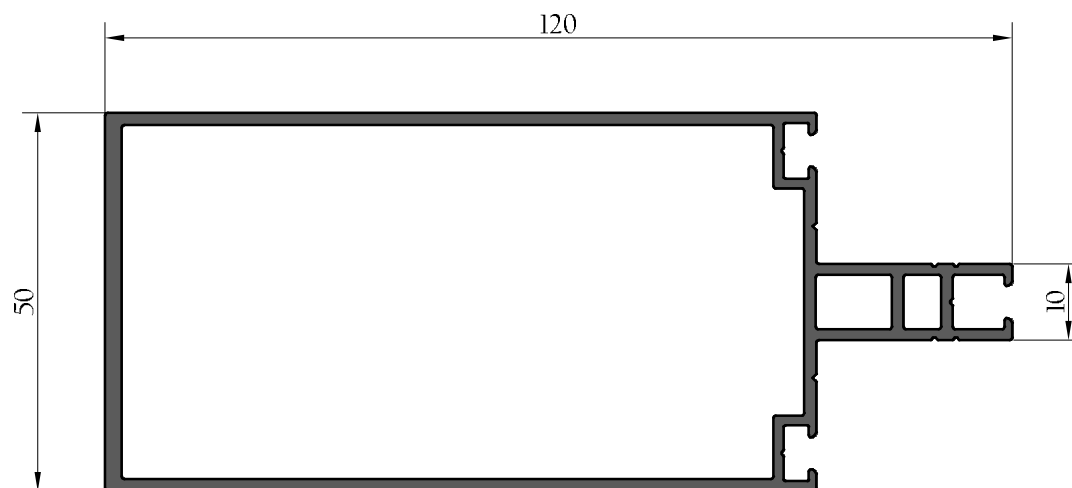

MENEAU-TRAVERSE 120 mm

5004

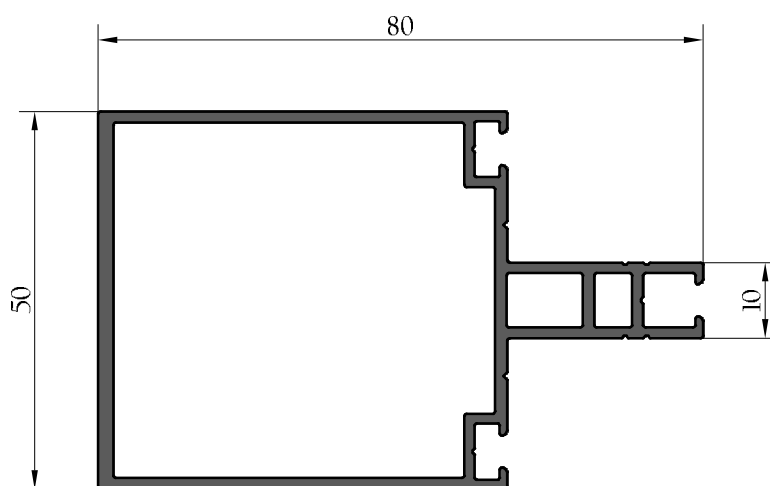

MENEAU-TRAVERSE 80 mm.

5003

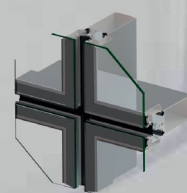

**PROFILES:**

VEC

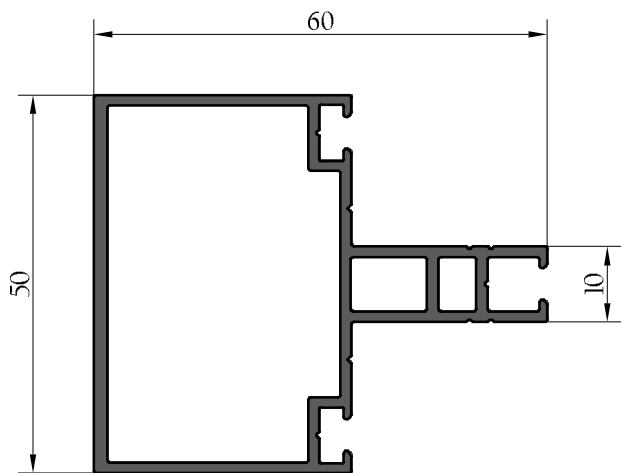

MENEAU-TRAVERSE 60 mm

5002

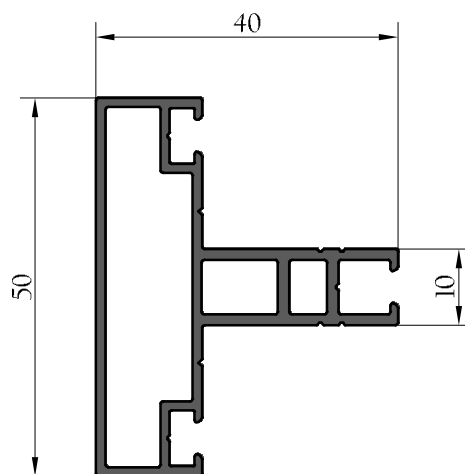

MENEAU-TRAVERSE 40 mm

5001

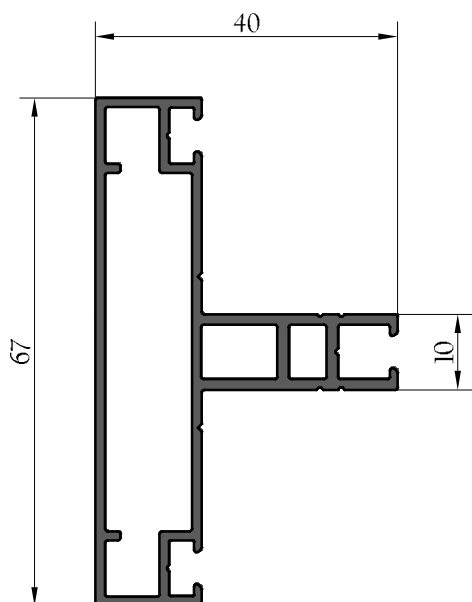

MENEAU-TRAVERSE LARGE 40 mm

5007

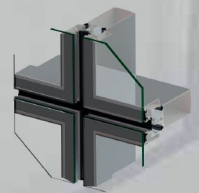

**PROFILES:**

VEC

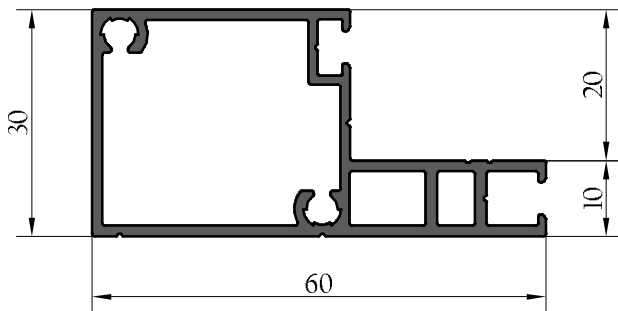

DEMI MENEAU-TRAVERSE 60 mm

5005

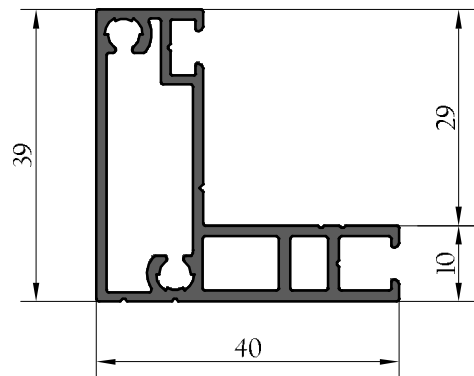

DEMI MENEAU-TRAVERSE 40 mm

5008

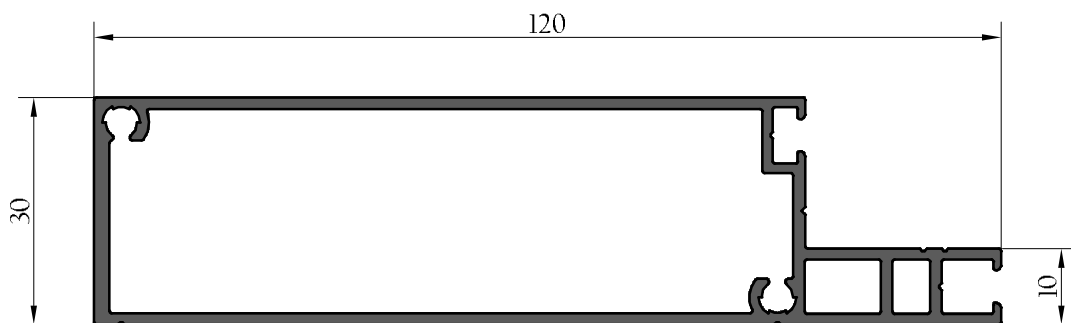

DEMI MENEAU-TRAVERSE 120 mm

5006

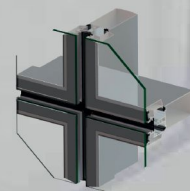

**PROFILES:**

**VEC**

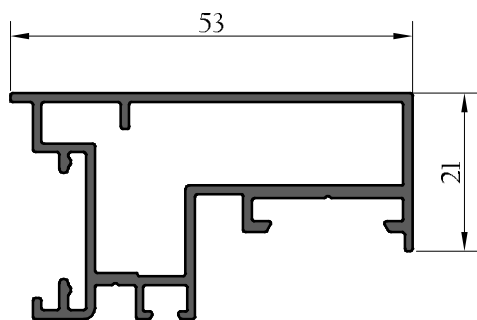

OUVRANT VEC

5010

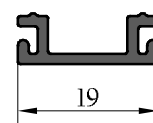

BARRETTE DE COLLAGE

5011

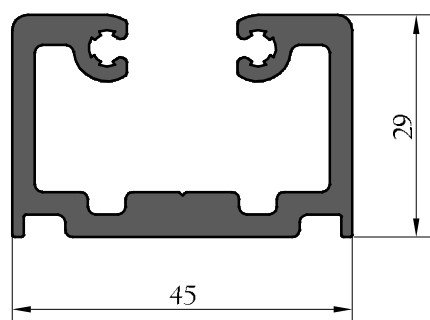

BLOC D'ASSEMBLAGE



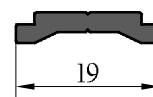



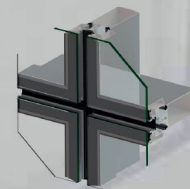

5030

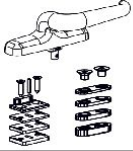
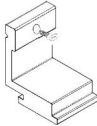
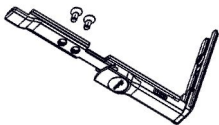
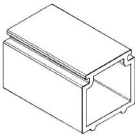

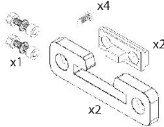
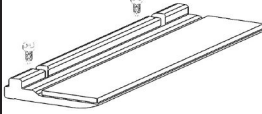
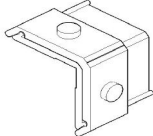
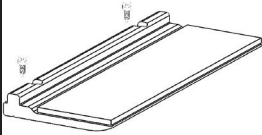
TIGE DE CREMONE

503

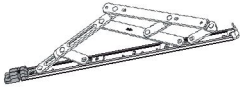
**ACCESSOIRES ET JOINTS:**
**VEC**

REF	ARTICLE	DESIGNATION	REF	ARTICLE	DESIGNATION
5110		crémone + kit	A5031		Pièce de fixation
5111		Renvoi d'angle	A5032		Pièce de repos
5115		Régulateur de position (+/-2mm)	A5035		Accroche mâle et femelle
A5012		Support de cale de simple vitrage (VEC)	E36-11D		Equeree à pion pour cadre V.E.C et semi V.E.C
A5013		Support de cale de double vitrage (VEC)	5200		Joint à lèvres EPDM
5112		Paire de compas pour O.I (1600 à 1800mm) 120 à 130 kg	5201		Joint de batement
5113		Paire de compas pour O.I (1000 à 1200mm) 65 à 95 kg	5203		Joint de finition 3mm
5114		Paire de compas pour O.I (600 à 800mm) 45 à 70 kg			

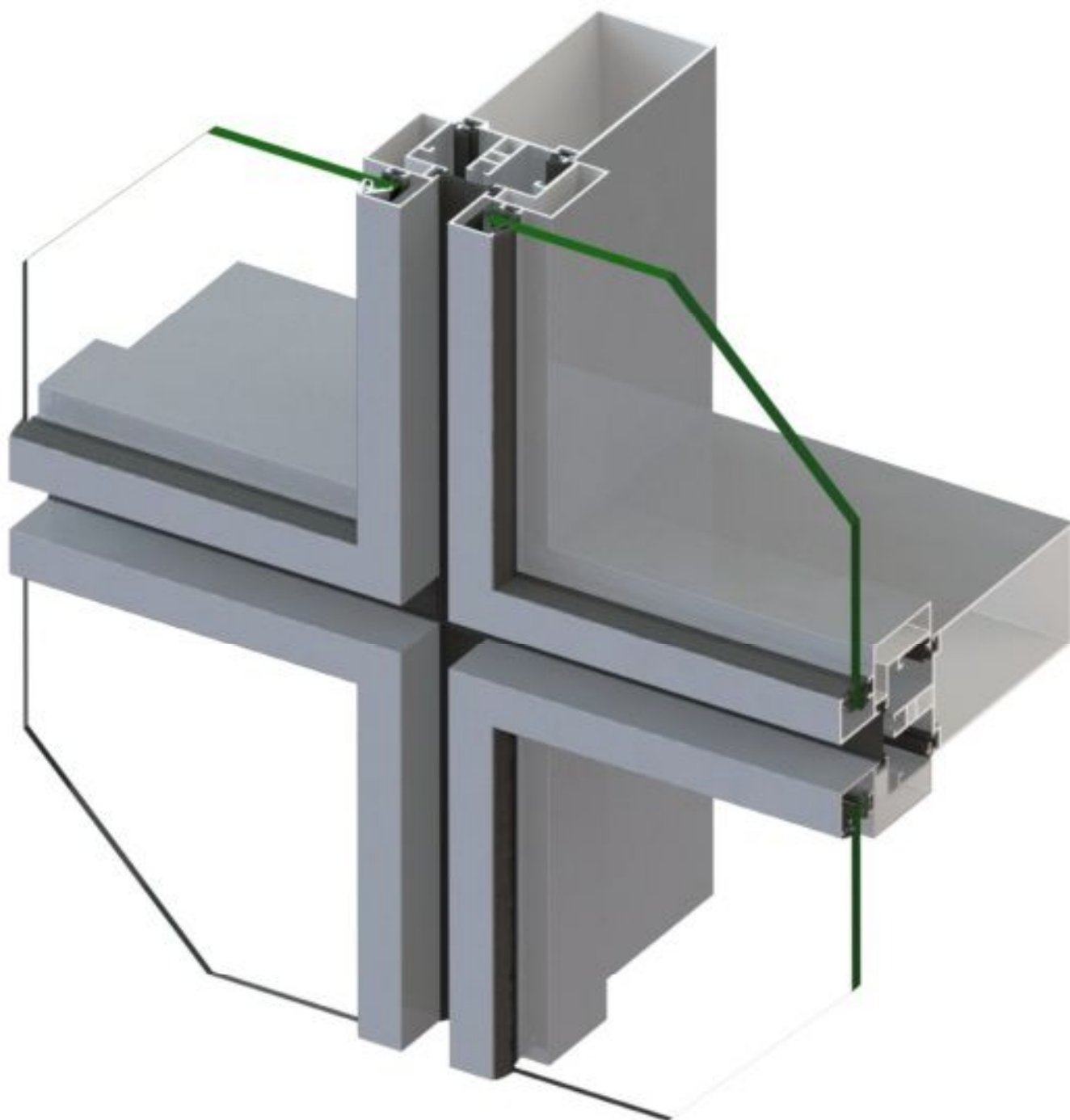
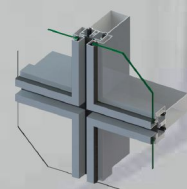

Semi-Vec

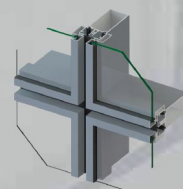

**PROFILES:**

**SEMI-VEC**

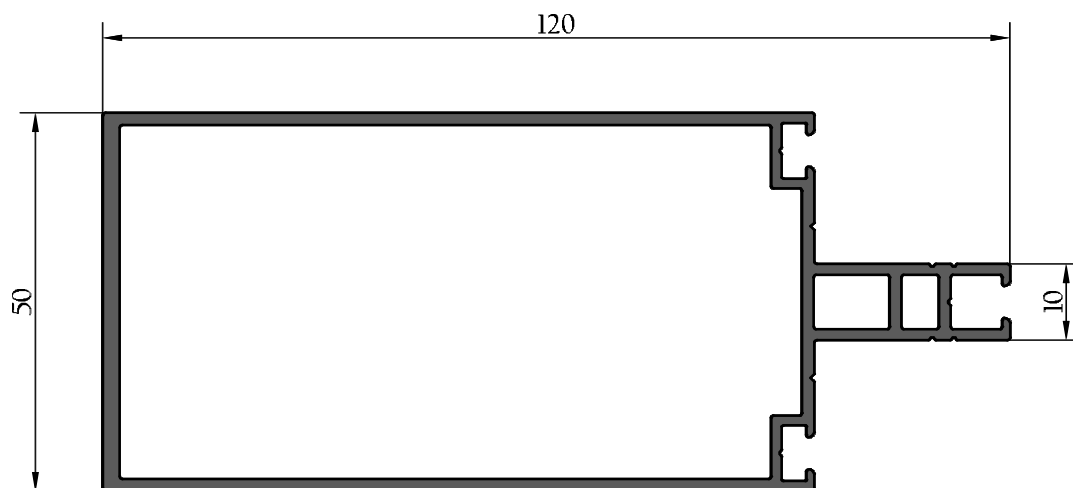

MENEAU-TRAVERSE 120 mm

5004

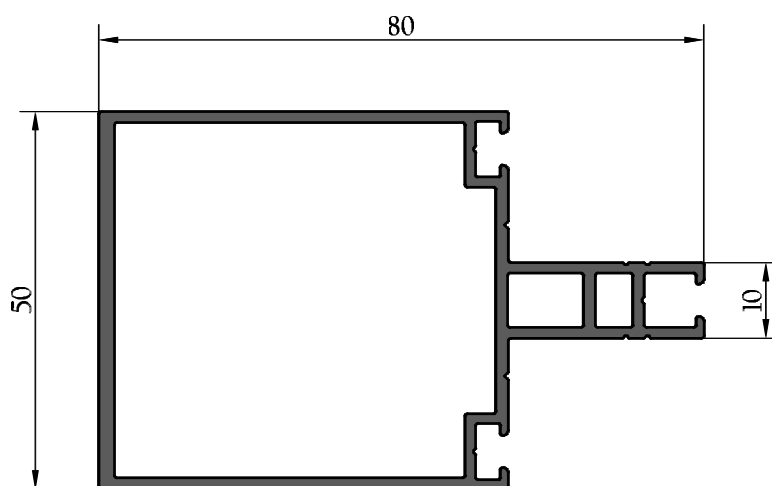

MENEAU-TRAVERSE 80 mm.

5003



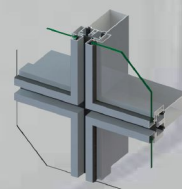

**PROFILES:**

**SEMI-VEC**

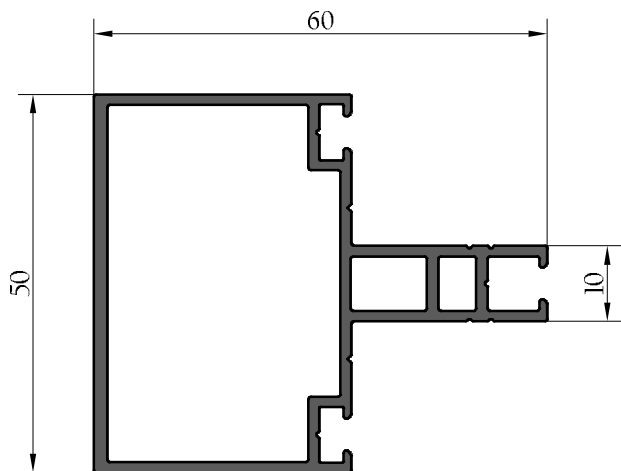

MENEAU-TRAVERSE 60 mm

5002

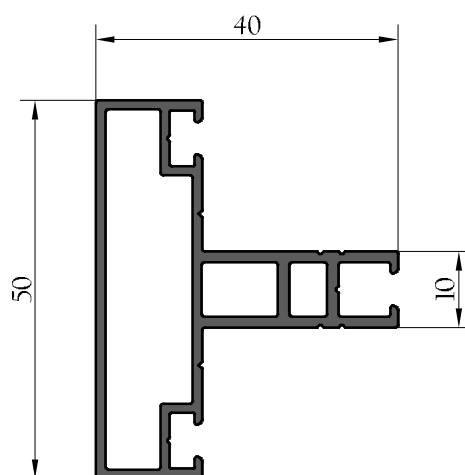

MENEAU-TRAVERSE 40 mm

5001

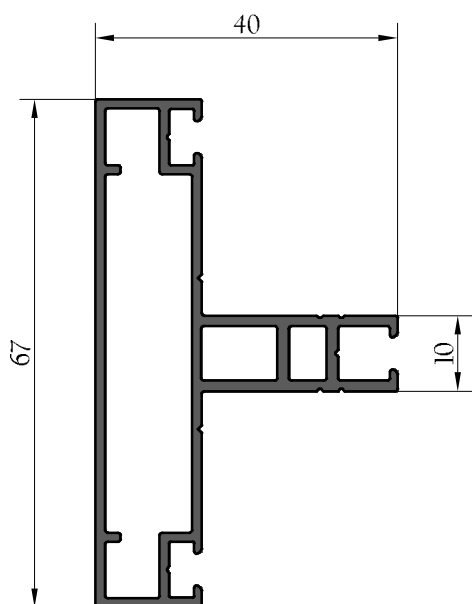

MENEAU-TRAVERSE LARGE 40 mm

5007

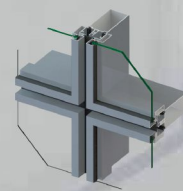

**PROFILES:**

**SEMI-VEC**

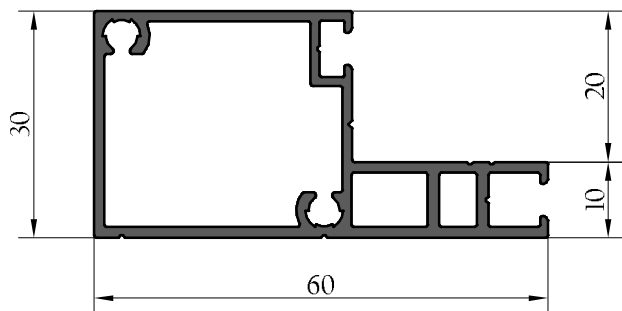

DEMI MENEAU-TRAVERSE 60 mm

5005

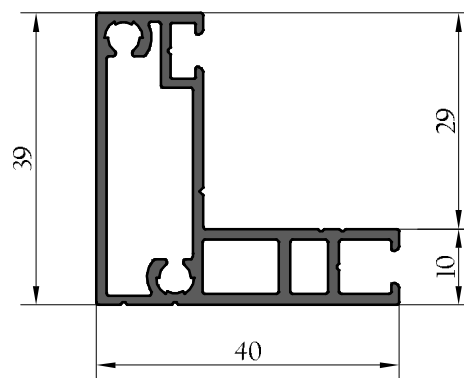

DEMI MENEAU-TRAVERSE 40 mm

5008

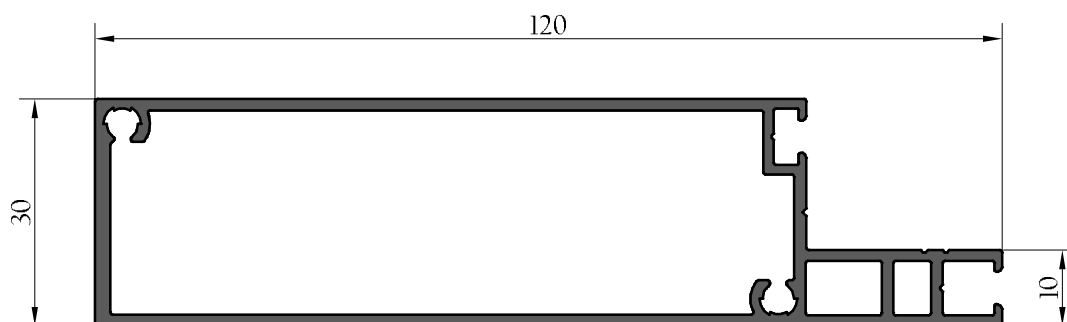

DEMI MENEAU-TRAVERSE 120 mm

5006

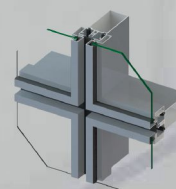

PROFILES:

SEMI-VEC

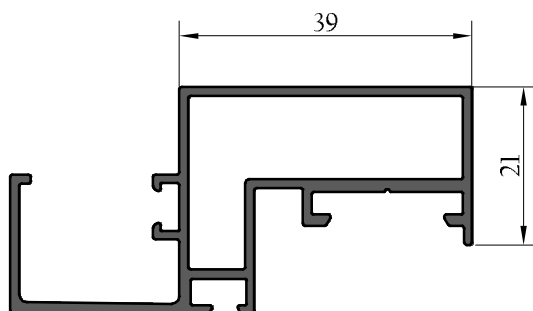

OUVRANT SEMI-VEC

5020

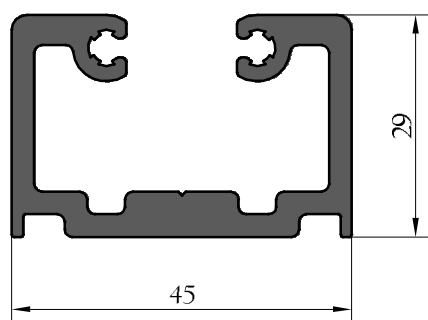

BLOC D'ASSEMBLAGE



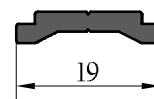





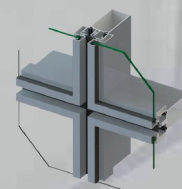

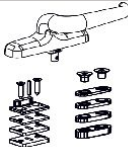
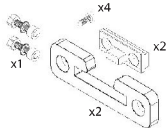
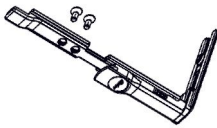
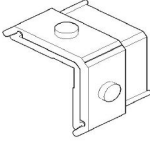

5030

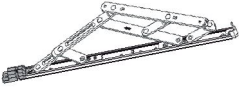

TIGE DE CREMONE

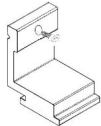
503

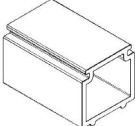
**ACCESSOIRES ET JOINTS:**
**SEMI-VEC**

REF	ARTICLE	DESIGNATION	REF	ARTICLE	DESIGNATION
5110		crémone + kit	A5035		Accroche mâle et femelle
5111		Renvoi d'angle	E36-11D		Equeree à pion pour cadre V.E.C et semi V.E.C
5115		Régulateur de position (+/-2mm)	5203		Joint de finition 3mm
5112		Paire de compas pour O.I (1600 à 1800mm) 120 à 130 kg	5202		Joint à lèvres
5113		Paire de compas pour O.I (1000 à 1200mm) 65 à 95 kg	5025		Joint d'assise de 5mm
5114		Paire de compas pour O.I (600 à 800mm) 45 à 70 kg	5201		Joint de batement
A5031		Pièce de fixation	597		Joint bourage 6mm
A5032		Pièce de repos	595		Joint bourage 4mm

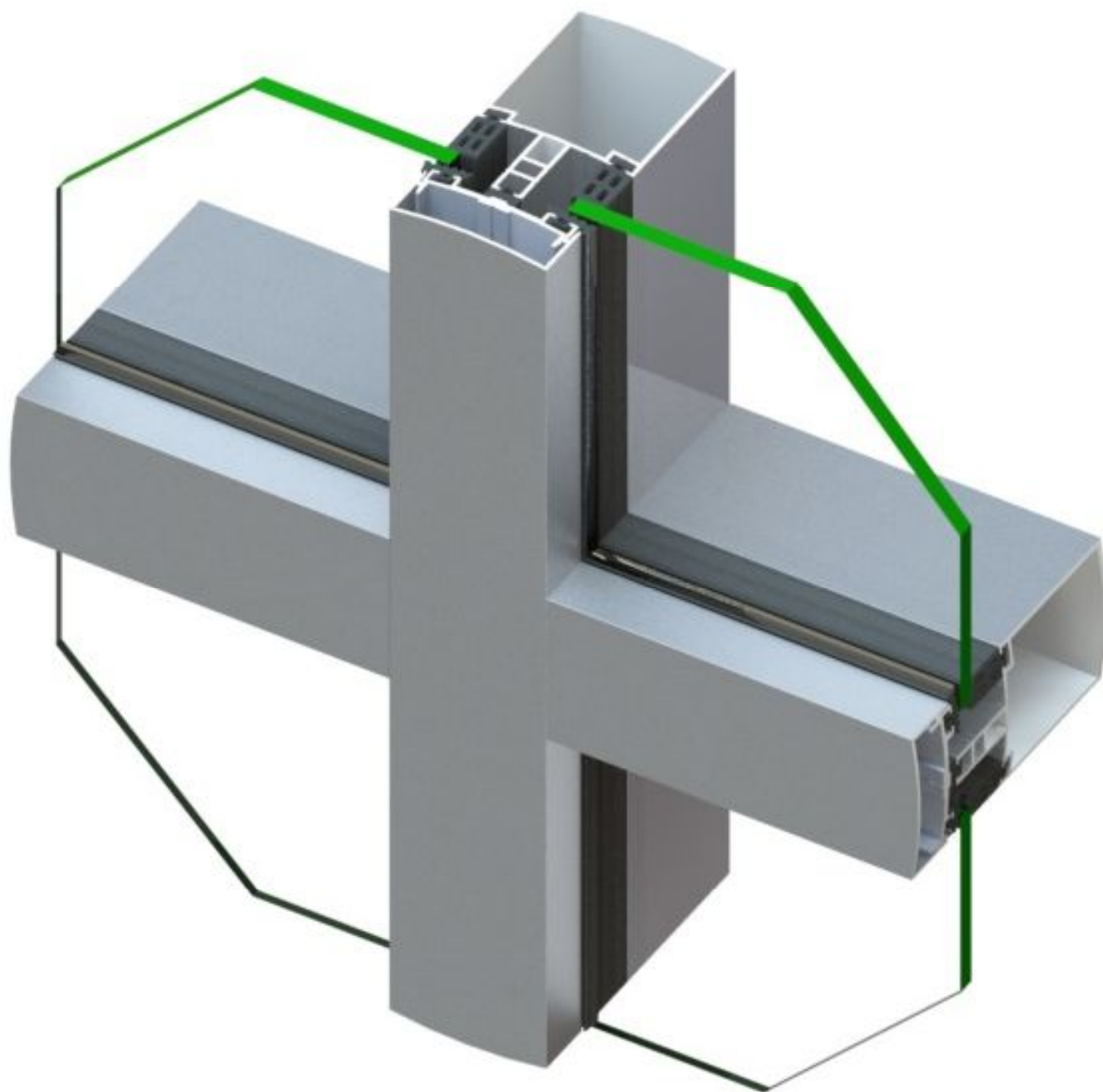
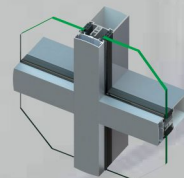

# Capot et Serreur

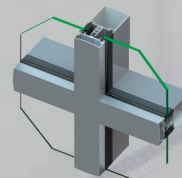

**PROFILES:**

**CAPOT ET SERREUR**

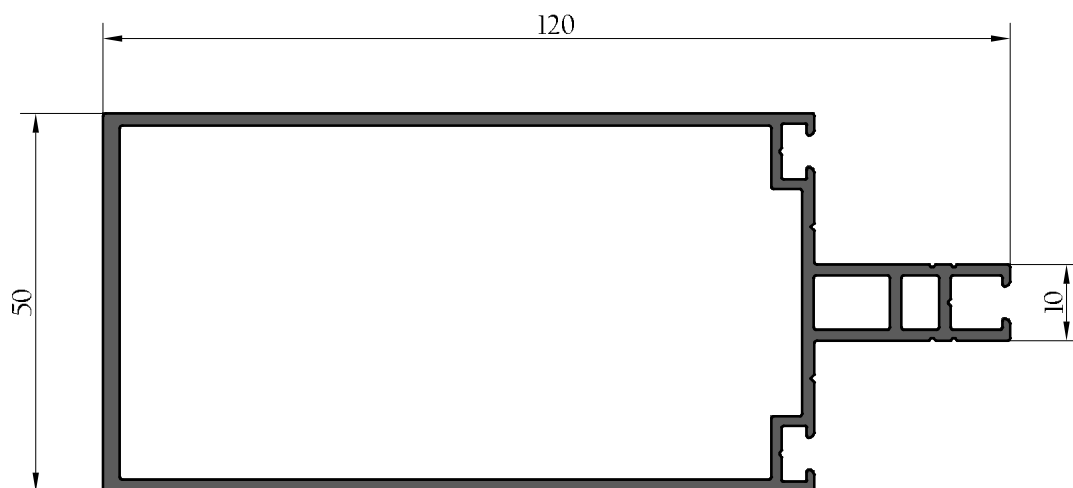

MENEAU-TRAVERSE 120 mm

5004

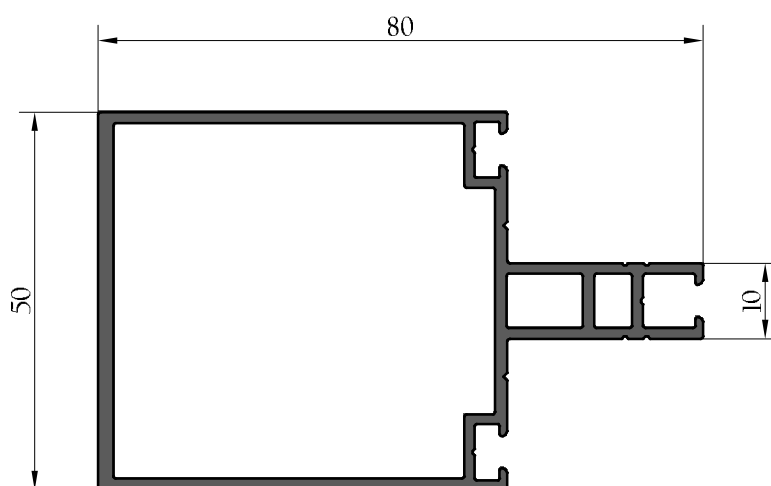

MENEAU-TRAVERSE 80 mm.

5003

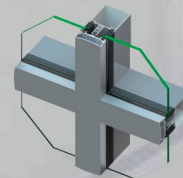

**PROFILES:**

**CAPOT ET SERREUR**

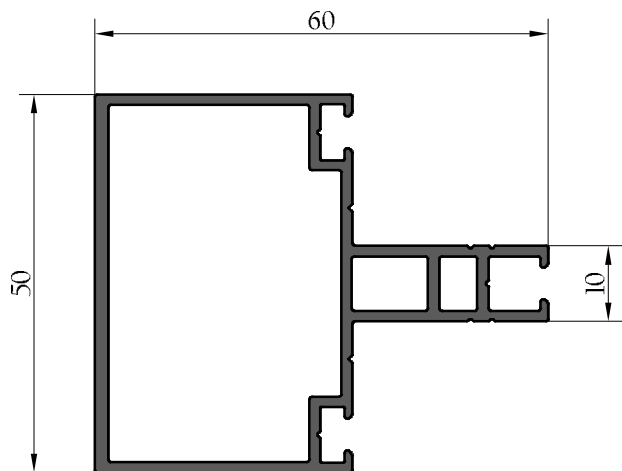

MENEAU-TRAVERSE 60 mm

5002

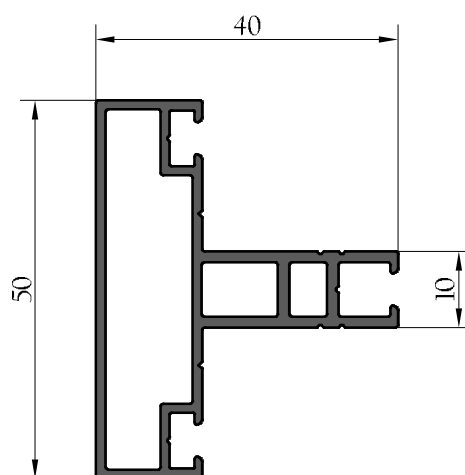

MENEAU-TRAVERSE 40 mm

5001

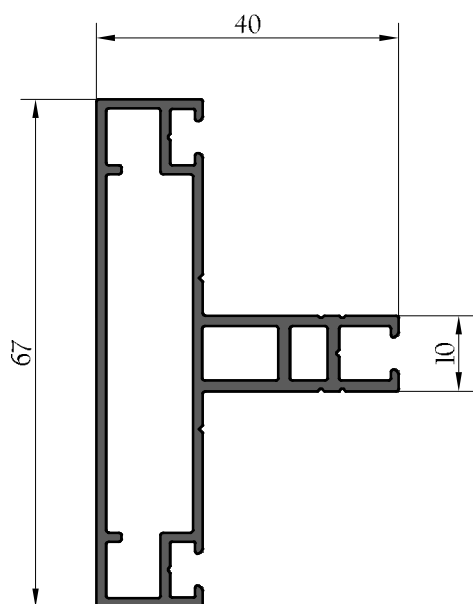

MENEAU-TRAVERSE LARGE 40 mm

5007

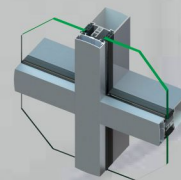

**PROFILES:**

**CAPOT ET SERREUR**

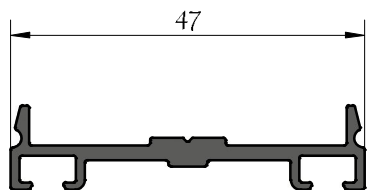

SERREUR  
5025

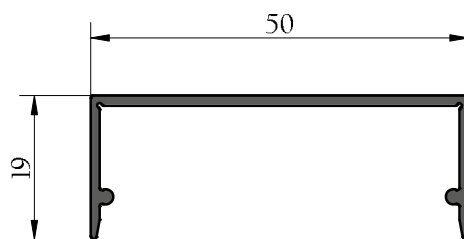

CAPOT PLAT  
5026

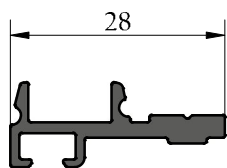

DEMI SERREUR  
5029

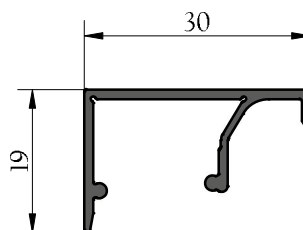

DEMI CAPOT  
5028

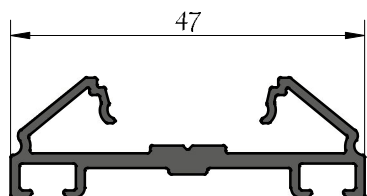

SERREURE  
5037

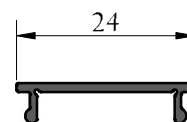

CAPOT  
5038



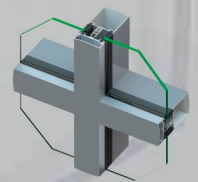

**PROFILES:**

**CAPOT ET SERREUR**

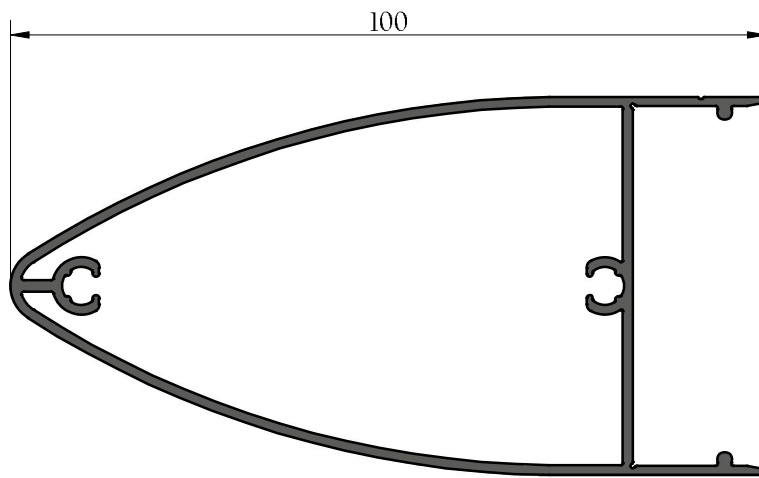

CAPOT OGIVE

5027

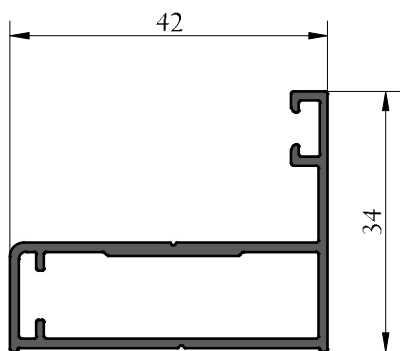

DORMANT VEC

5009

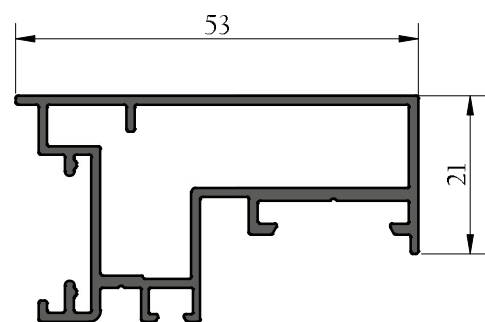

OUVRANT VEC

5010

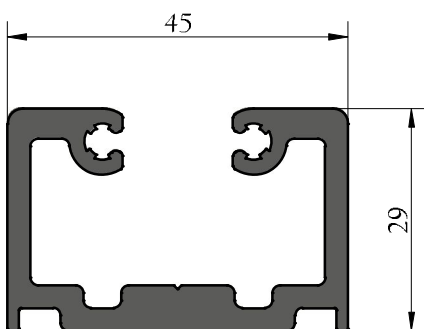

BLOC D'ASSEMBLAGE

5030

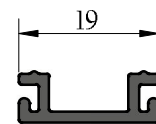

BARRETTE DE COLLAGE

5011

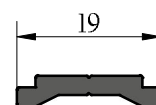

TIGE DE CREMONE

503

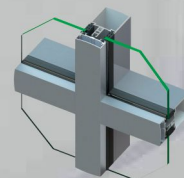
**ACCESSOIRES ET JOINTS:**
**CAPOT ET SERREUR**

REF	ARTICLE	DESIGNATION	REF	ARTICLE	DESIGNATION
5110		crémone + kit	5217		Joint d'assise de 17mm EPDM
5111		Renvoi d'angle	5215		Joint d'assise de 15mm EPDM
5115		Régulateur de position (+/-2mm)	5213		Joint d'assise de 13mm EPDM
A5012		Support de cale simple vitrage (VEC)	5211		Joint d'assise de 11mm EPDM
A5013		Support de cale double vitrage (VEC)	5209		Joint d'assise de 9mm EPDM
5112		Paire de compas pour O.I (1600 à 1800mm) 120 à 130 kg	5207		Joint d'assise de 7mm EPDM
5113		Paire de compas pour O.I (1000 à 1200mm) 65 à 95 kg	5205		Joint d'assise de 5mm EPDM
5114		Paire de compas pour O.I (600 à 800mm) 45 à 70 kg	5204		Joint de coupure thermique de 4mm EPDM
E36-11D		Equerree à pion pour cadre V.E.C et semi V.E.C	5203		Joint de finition 3mm
5201		Joint de batement	5200		Joint à lèvres EPDM
5223		Joint serreur			

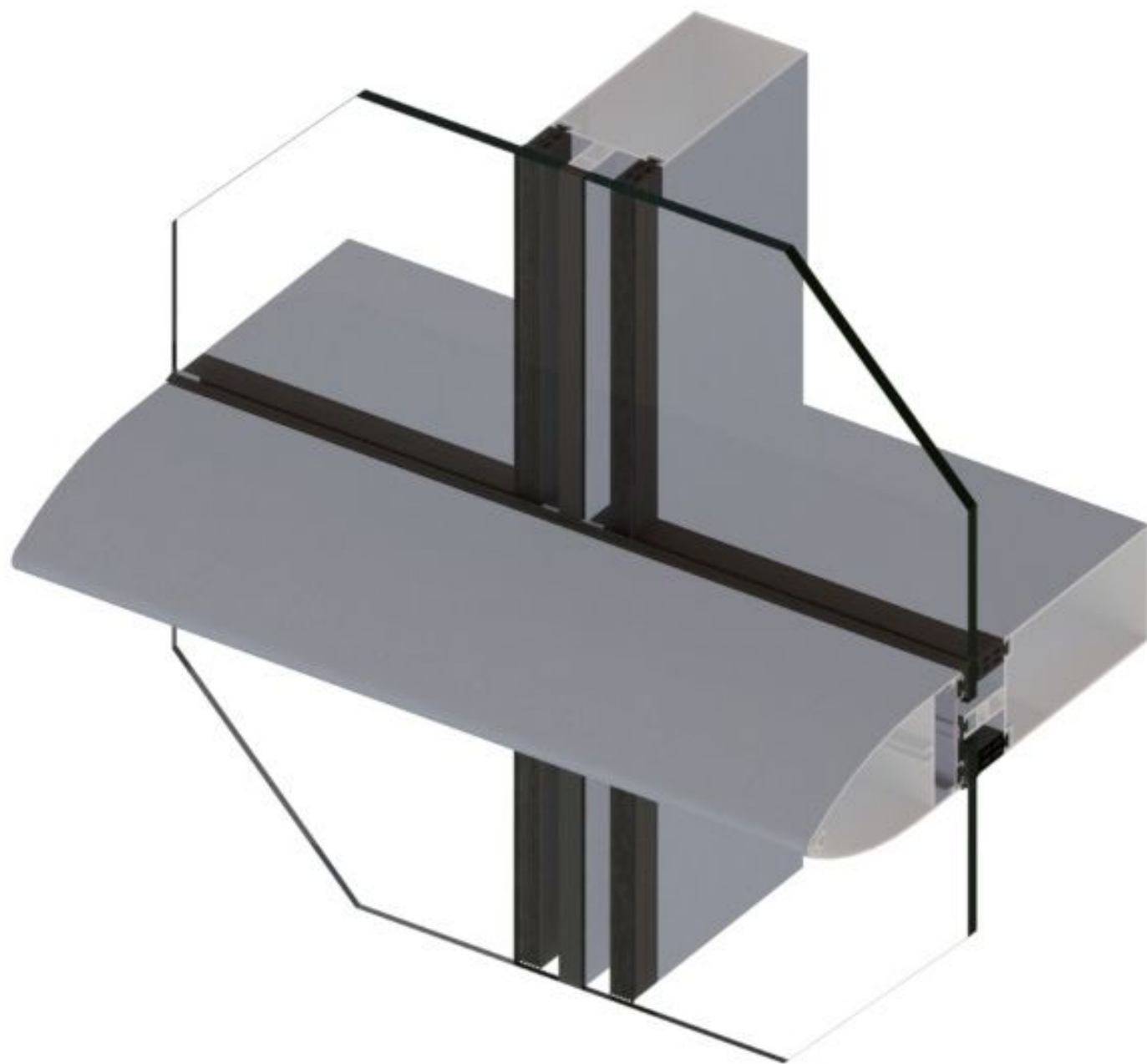
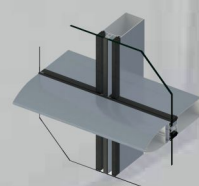

# Trame Horizontale

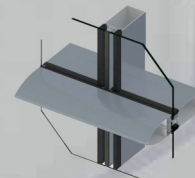

**PROFILES:**

**TRAME HORIZONTALE**

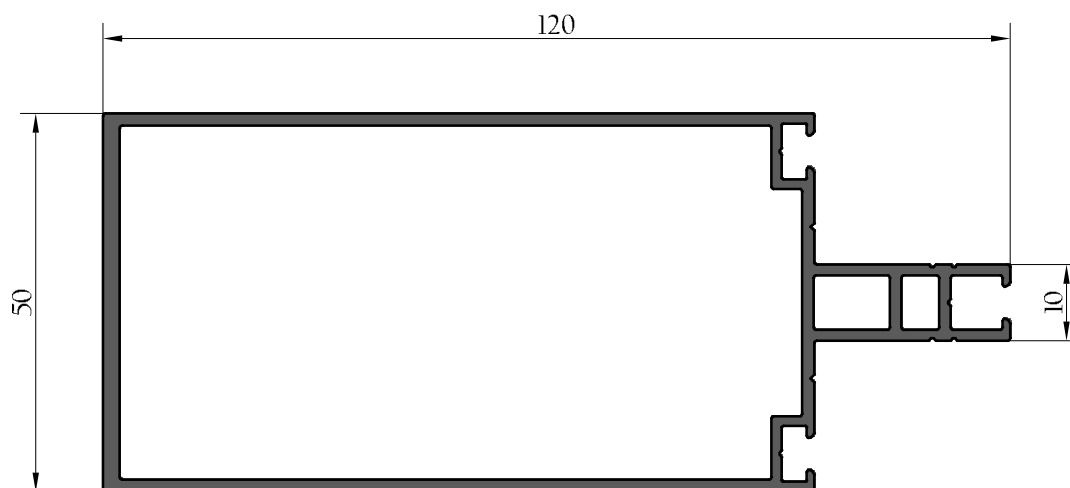

MENEAU-TRAVERSE 120 mm

5004

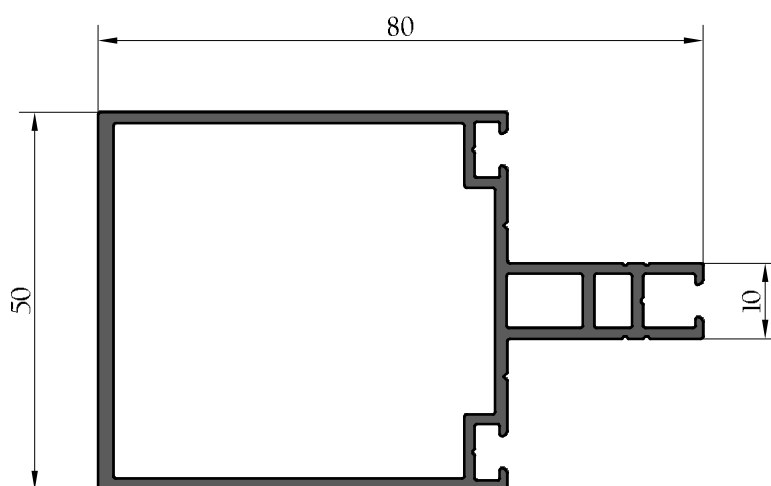

MENEAU-TRAVERSE 80 mm.

5003

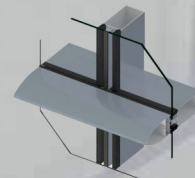

**PROFILES:**

**TRAME HORIZONTALE**

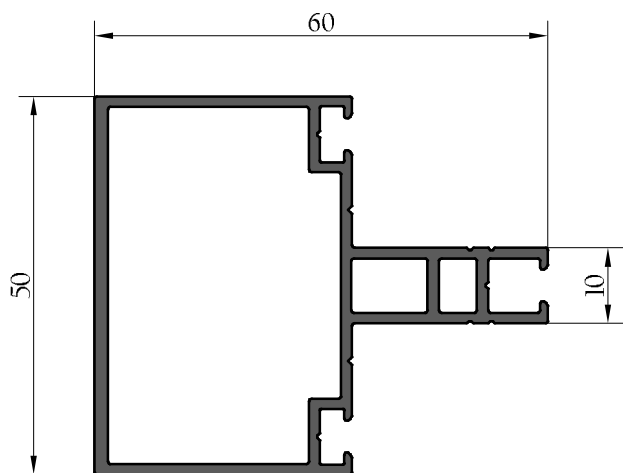

MENEAU-TRAVERSE 60 mm

5002

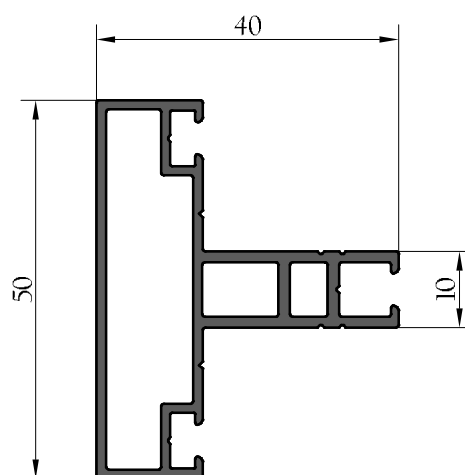

MENEAU-TRAVERSE 40 mm

5001

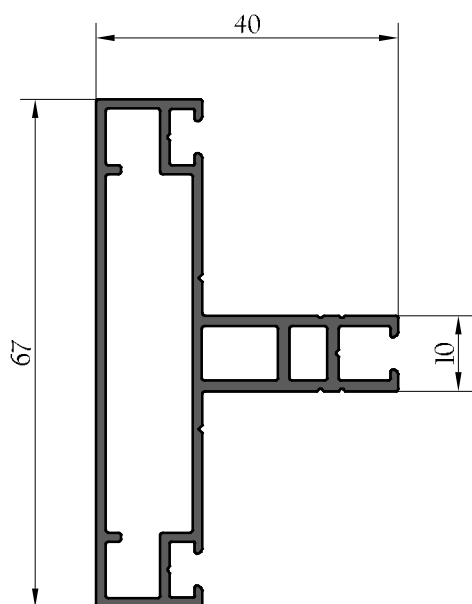

MENEAU-TRAVERSE LARGE 40 mm

5007

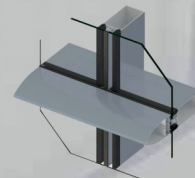

**PROFILES:**

**TRAME HORIZONTALE**

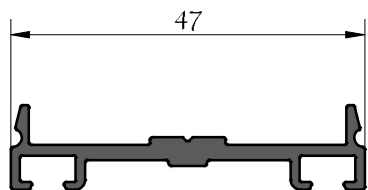

SERREUR  
5025

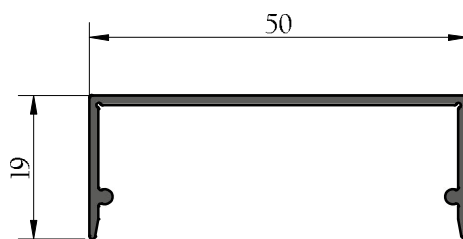

CAPOT PLAT  
5026

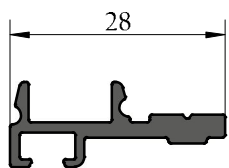

DEMI SERREUR  
5029

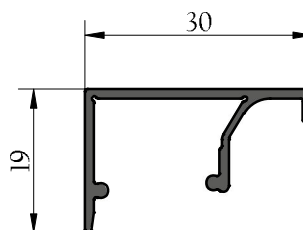

DEMI CAPOT  
5028

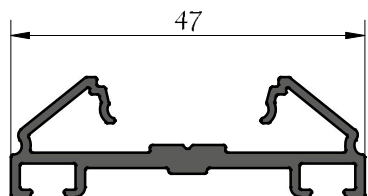

SERREUR  
5037

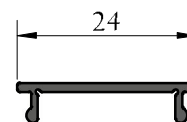

CAPOT  
5038

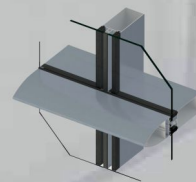

**PROFILES:**

**TRAME HORIZONTALE**

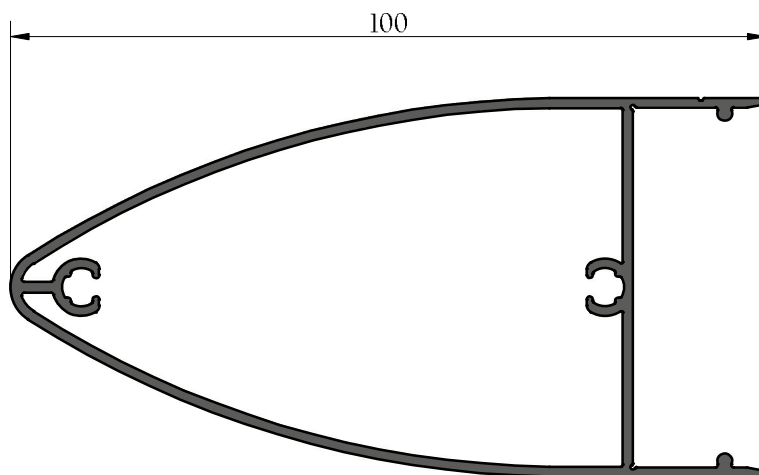

CAPOT OGIVE

5027

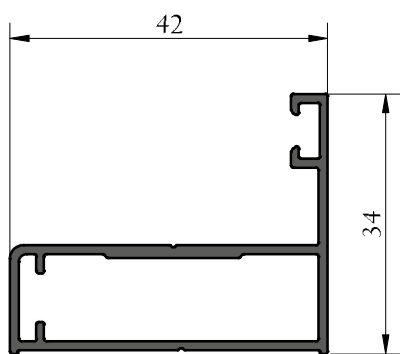

DORMANT VEC

5009

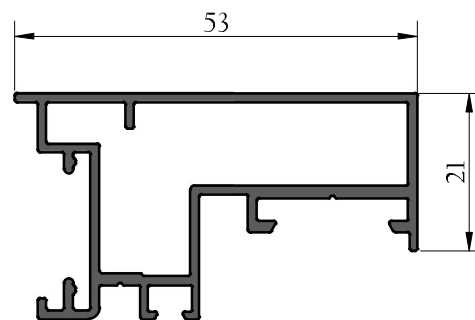

OUVRANT VEC

5010

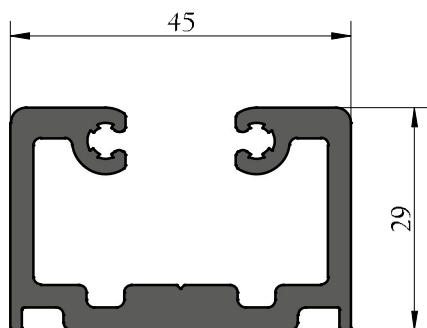

BLOC D'ASSEMBLAGE

5030

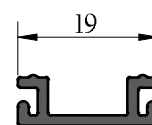

BARRETTE DE COLLAGE

5011

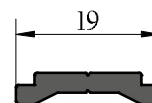

TIGE DE CREMONE

503

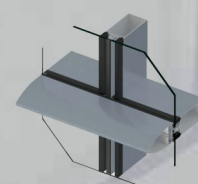
**ACCESSOIRES ET JOINTS:**
**TRAME HORIZONTALE**

REF	ARTICLE	DESIGNATION	REF	ARTICLE	DESIGNATION
5110		crémone + kit	5217		Joint d'assise de 17mm EPDM
5111		Renvoi d'angle	5215		Joint d'assise de 15mm EPDM
5115		Régulateur de position (+/-2mm)	5213		Joint d'assise de 13mm EPDM
A5012		Support de cale simple vitrage (VEC)	5211		Joint d'assise de 11mm EPDM
A5013		Support de cale double vitrage (VEC)	5209		Joint d'assise de 9mm EPDM
5112		Paire de compas pour O.I (1600 à 1800mm) 120 à 130 kg	5207		Joint d'assise de 7mm EPDM
5113		Paire de compas pour O.I (1000 à 1200mm) 65 à 95 kg	5205		Joint d'assise de 5mm EPDM
5114		Paire de compas pour O.I (600 à 800mm) 45 à 70 kg	5204		Joint de coupure thermique de 4mm EPDM
E36-11D		Equeree à pion pour cadre V.E.C et semi V.E.C	5203		Joint de finition 3mm
5201		Joint de batement	5200		Joint à lèvres EPDM
5223		Joint serreur			